

- PLC
- HMI
- SENSOR
- ENCODER**
- COUNTER
- INFORMATION

# TRD-N/NH Series

## Features

### φ50 Incremental Type

- Thin design with an outside diameter of φ50 mm / depth of 35 mm
- Protective structure selectable according to environment of use  
Aluminum die-cast case for dustproof and waterjet-proof type (IP65)
- A wide range of resolution (1 to 5,000 P/R).
- Uses robust φ8 mm stainless steel shaft.
- Wide power range of 4.75 to 30 V DC
- Installation using a servo mount convenient for origin adjustment is possible.



### Model Number List

Type	Appearance	Model Number	Output	Pulse Number / Rotation
Dustproof type ABS plastic cover		TRD-N□-S	1-phase output	1, 3, 4, 5, 10, 20, 30, 60, 100, 120, 200, 300, 360, 500, 600, 1,000
		TRD-N□-RZ	Output with 2-phase origin (Origin direct action □)	3, 4, 5, 10, 20, 30, 40, 50, 60, 100, 120, 200, 240, 250, 300, 360, 400, 480, 500, 600, 750, 1,000, 1,200, 2,000, 2,500, 3,600, 4,096, 5,000
		TRD-N□-RZL	Output with 2-phase origin (Origin reverse action □)	
		TRD-N□-RZV	Output with 2-phase origin (Origin direct action □)	
Dustproof and Waterjet-proof Type Aluminium die-cast cover		TRD-N□-SW	1-phase output	1, 3, 4, 5, 10, 20, 30, 60, 100, 120, 200, 300, 360, 500, 600, 1,000
		TRD-N□-RZW	Output with 2-phase origin (Origin direct action □)	3, 4, 5, 10, 20, 30, 40, 50, 60, 100, 120, 200, 240, 250, 300, 360, 400, 480, 500, 600, 750, 1,000, 1,200, 2,000, 2,500, 3,600, 4,096, 5,000
		TRD-N□-RZWL	Output with 2-phase origin (Origin reverse action □)	
		TRD-N□-RZVW	Output with 2-phase origin (Origin direct action □)	
Dustproof Hollow Shaft Type ABS plastic cover		TRD-NH□-S	1-phase output	1, 3, 4, 5, 10, 20, 30, 60, 100, 120, 200, 300, 360, 500, 600, 1,000
		TRD-NH□-RZ	Output with 2-phase origin (Origin direct action □)	3, 4, 5, 10, 20, 30, 40, 50, 60, 100, 120, 200, 240, 250, 300, 360, 400, 480, 500, 600, 750, 1,000, 1,200, 2,000, 2,500, 3,600, 4,096, 5,000
		TRD-NH□-RZL	Output with 2-phase origin (Origin reverse action □)	
		TRD-NH□-RZV	Output with 2-phase origin (Origin direct action □)	
Dustproof, Waterjet-proof Hollow Shaft Type Aluminium die-cast cover		TRD-NH□-SW	1-phase output	1, 3, 4, 5, 10, 20, 30, 60, 100, 120, 200, 300, 360, 500, 600, 1,000
		TRD-NH□-RZW	Output with 2-phase origin (Origin direct action □)	3, 4, 5, 10, 20, 30, 40, 50, 60, 100, 120, 200, 240, 250, 300, 360, 400, 480, 500, 600, 750, 1,000, 1,200, 2,000, 2,500, 3,600, 4,096, 5,000
		TRD-NH□-RZWL	Output with 2-phase origin (Origin reverse action □)	
		TRD-NH□-RZVW	Output with 2-phase origin (Origin direct action □)	

TRD- N □ - RZ W L - □

- Series classification  
**N** : Shaft type  
**NH**: Hollow shaft type
- Pulse number
- Signal format  
**S** : 1-phase output  
**RZ** : Output with 2-phase origin (Origin direct action)  
**RZV**: Line driver output
- Protective structure  
Blank: Dustproof type (IP50)  
**W** : Dustproof, waterjet-proof type (IP65)
- Origin reverse action symbol  
If the signal type is RZ, models with "L" produce the origin reverse action.
- (Special specifications products)

# TRD-N/NH Series

## Specifications/Dimensions

- PLC
- HMI
- SENSOR
- ENCODER
- COUNTER
- INFORMATION

- Rotary Encoder Lineup
- Selection Guide
- Incremental Type
- Absolute Type

### Pulse and Frequencies

Pulse Number per Rotation	1	3	4	5	10	20	30	40	50	60	100	120	200	240	250	300	360	400	480	500	600	750	1,000	1,200	2,000	2,500	3,600	4,096	5,000		
Maximum Response Frequency (kHz)*1	0.08	0.25	0.33	0.41	0.8	1.6	2.5	3.3	4.1	4.9	8.3	9.9	16	19	20	24	29	33	39	41	49	62	83	100	100	100	100	100	200	200	
Applicable Models	TRD-N□-S□	●	●	●	●	●	●			●	●	●	●			●	●			●	●		●								
	TRD-NH□-S□	●	●	●	●	●	●			●	●	●	●			●	●			●	●		●								
	TRD-N□-RZ□		●	●	●	●	●	●	●	●	●	●	●	●	●	●	●	●	●	●	●	●	●	●	●	●	●	●	●	●	●
	TRD-NH□-RZ□		●	●	●	●	●	●	●	●	●	●	●	●	●	●	●	●	●	●	●	●	●	●	●	●	●	●	●	●	●
	TRD-N□-RZ□L		●	●	●	●	●	●	●	●	●	●	●	●	●	●	●	●	●	●	●	●	●	●	●	●	●	●	●	●	●
	TRD-NH□-RZ□L		●	●	●	●	●	●	●	●	●	●	●	●	●	●	●	●	●	●	●	●	●	●	●	●	●	●	●	●	●
	TRD-N□-RZV□		●	●	●	●	●	●	●	●	●	●	●	●	●	●	●	●	●	●	●	●	●	●	●	●	●	●	●	●	●
TRD-NH□-RZV□		●	●	●	●	●	●	●	●	●	●	●	●	●	●	●	●	●	●	●	●	●	●	●	●	●	●	●	●	●	

\*1 The electric maximum response frequency is specified by resolution (pulse number) and the maximum number of revolutions.  
 Electrical maximum number of revolutions = ((Maximum response frequency/Resolution) x 60)  
 Therefore, if the encoder rotates at a speed greater than the electrical maximum number of revolutions, the signals do not electrically follow.  
 \*2 The totem-pole output is 100 kHz and the line driver output is 200 kHz.

### Electrical Specifications

Model Number		TRD-N□-S□ TRD-NH□-S□	TRD-N□-RZV□ TRD-NH□-RZV□	TRD-N□-RZ□/TRD-N□-RZ□L TRD-NH□-RZ□/TRD-NH□-RZ□L	
Power Supply	Supply Voltage	4.75 to 30 V DC	4.75 to 5.25 V DC	4.75 to 30 V DC	
	Allowable Ripple	3% rms or less	3% rms or less	3% rms or less	
	Consumption Current (No Load)	40 mA or lower	60 mA or lower	60 mA or lower	
Output Waveform	Signal Format	1-phase output	2-phase output + home position	2-phase output + home position	
	Duty Ratio	50±25%	50±25%	50±25%	
	Signal Width at Home Position	—	100±50%	100±50%	
Output	Rise / Fall Time*	Not larger than 3 μs	Not larger than 2 μs	Not larger than 3 μs	
	Output Form	Totem-pole output	Line driver output	Totem-pole output	
	Output Current	Source "H"	Up to 10 mA	—	Up to 10 mA
		Sink "L"	Up to 30 mA	—	Up to 30 mA
	Output Voltage	"H"	[(Supply Voltage) - 2.5 V] or more	2.5 V or higher	[(Supply Voltage) - 2.5 V] or more
		"L"	0.4 V or lower	0.5 V or lower	0.4 V or lower
Load Supply Voltage	35 V DC or lower	—	35 V DC or lower		

\* Cable 0.5 m or shorter, maximum load

### Mechanical Specifications

Starting Torque	Dustproof type: 0.003 N·m or less (+20°C)/Dustproof and waterjet-proof type (W type): 0.02 N·m or less (+20°C)/Hollow shaft type: 0.05 N·m or less (+20°C)
Moment of Inertia	2 x 10 <sup>-6</sup> kg·m <sup>2</sup>
Shaft Allowable Load	Radial: 50 N
	Thrust: 30 N
Maximum Allowable Number of Revolutions (Note 1)	5,000 rpm (However, 3,000 rpm (continuously) and 5,000 rpm (instantaneously) for dustproof and waterjet-proof type)
Cable	Outside diameter φ6 mm 5-core shielded oil-resistant cable Core wire nominal cross-sectional area: 0.3 mm <sup>2</sup> (Line driver output is 8 cores, 0.14 mm <sup>2</sup> )
Weight	Approx. 150 g (Approx. 200 g for dustproof and waterjet-proof type)

Note 1: Maximum number of revolutions that can be mechanically endured

### Bearing Life

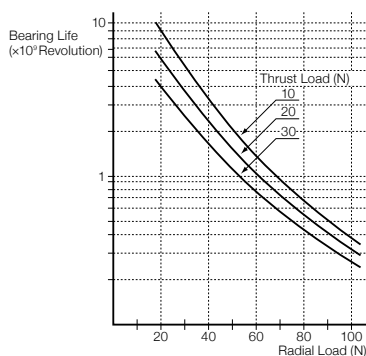

### Environmental Requirements

Use Ambient Temperature	-10 to +70°C
Storage Ambient Temperature	-25 to +85°C
Use Ambient Humidity	35 to 85% RH (No condensation)
Withstand Voltage	500 V AC (50/60 Hz) 1 minute RZV series Excluded due to capacitor grounding (The signal lines, and shield between the cases are excluded)
Insulation Resistance	50 MΩ or higher
Vibration Resistance (Endurance)	Displacement half amplitude: 0.75 mm, 10 to 55 Hz, 3 axial directions, each 1 h
Impact Resistance (Endurance)	Up to 500P/R (Metal slit) 981 m/s <sup>2</sup> 11 ms, each 3 times in 3 axial directions 600 P/R or higher (Glass slit) 490 m/s <sup>2</sup> 11 ms, each 3 times in 3 axial directions
Protective Structure	Dustproof type: IP50 Dustproof and Waterjet-proof type: IP65

- TRD-MX
- TRD-S/SH
- TRD-2E
- TRD-N/NH
- TRD-J
- TRD-GK

# TRD-N/NH Series

## Specifications

- P L C
- H M I
- SENSOR
- ENCODER
- COUNTER
- INFORMATION

### Output Waveform

#### Totem-pole

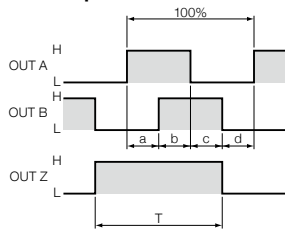

$$12.5\% \leq a, b, c, d \leq 37.5\%$$

$$50\% \leq T \leq 150\%$$

Note: Clockwise (normal) rotation when the main body is seen from the axle side  
: Z-phase logic is reverse for the RZL and RZWL types.

#### Line Driver

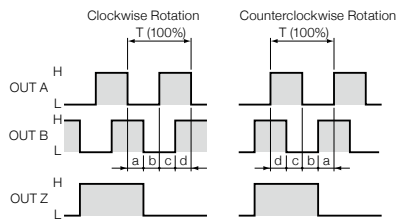

$$12.5\% \leq a, b, c, d \leq 37.5\%$$

$$50\% \leq T \leq 150\%$$

Note: Clockwise rotation when the main body is seen from the axle side is the normal rotation.

### Output Circuit

#### Totem-pole

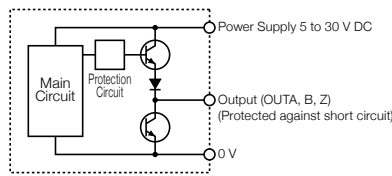

#### Line Driver

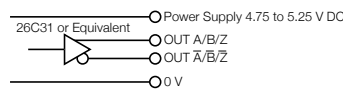

- The line driver output comes from a data transmission circuit that conforms to RS-422A and can transmit data up to 1,200 m over twisted pair cables.

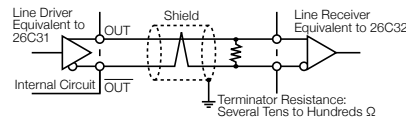

- When the transmission line or connector is disconnected, the output becomes "H".

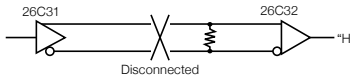

### Connection Diagram

#### Totem-pole

##### 《1-phase output》

The shielded wire is connected to the main body.

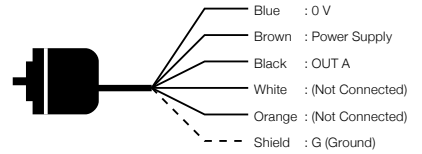

##### 《Output with 2-phase origin》

The shielded wire is connected to the main body.

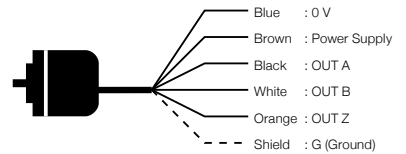

#### Line Driver

The shielded wire is connected to the main body.

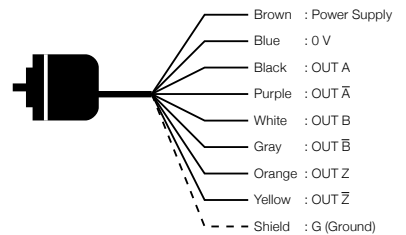

### Electrical Characteristics (Typical)

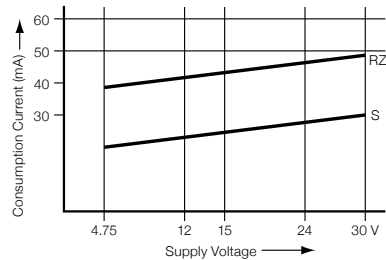

- Rotary Encoder Lineup
- Selection Guide
- Incremental Type
- Absolute Type

- TRD-MX
- TRD-S/SH
- TRD-2E
- TRD-N/NH
- TRD-J
- TRD-GK



- PLC
- HMI
- SENSOR
- ENCODER
- COUNTER
- INFORMATION

# TRD-N/NH Series

## Dimensions

### TRD-NH Series [Dustproof Type: S/RZ/RZL/RZV]

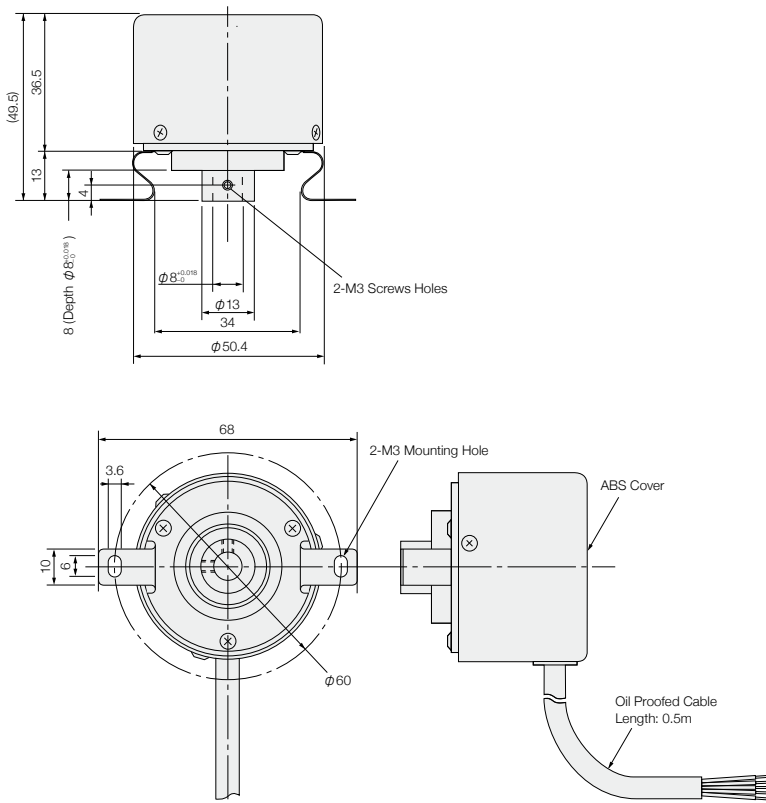



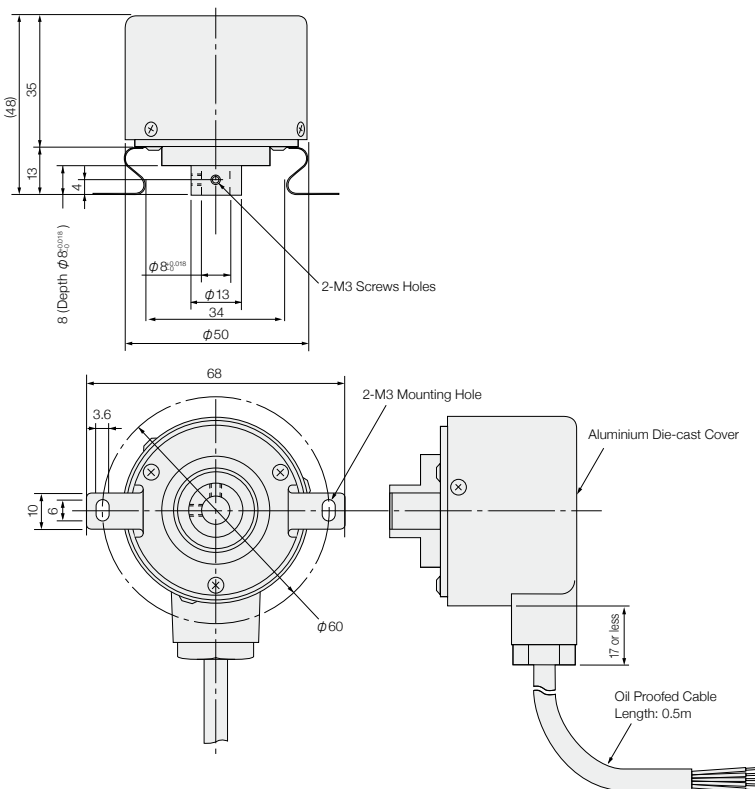



### TRD-NH Series [Dustproof and Waterjet-proof Type: SW/RZW/RZWL/RZVW]



- TRD-MX
- TRD-S/SH
- TRD-2E
- TRD-N/NH**
- TRD-J
- TRD-GK

# TRD-N/NH Series

## Dimensions

- PLC 
- HMI 
- SENSOR 
- ENCODER** 
- COUNTER 
- INFORMATION 

Mounting Point Shape

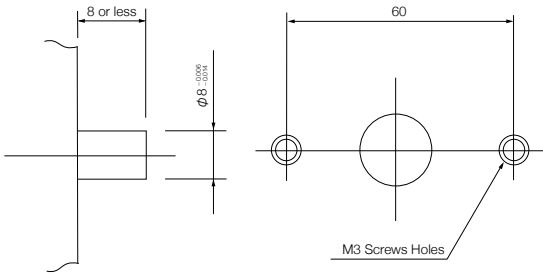

Shaft Direction Variation

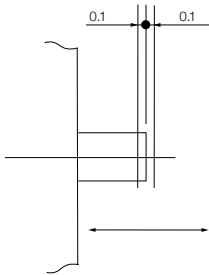

Shaft Angle Direction Variation

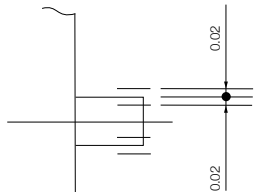

Degree of Mounting Surface Angle Over Shaft.

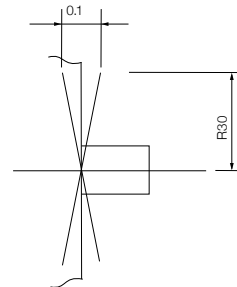

- Rotary Encoder Lineup
- Selection Guide
- Incremental Type**
- Absolute Type

- TRD-MX
- TRD-S/SH
- TRD-2E
- TRD-N/NH**
- TRD-J
- TRD-GK